

Tipo	Area
CORTE	0.00
RELLENO	3.54
RELLENO CUNETETA	0.76

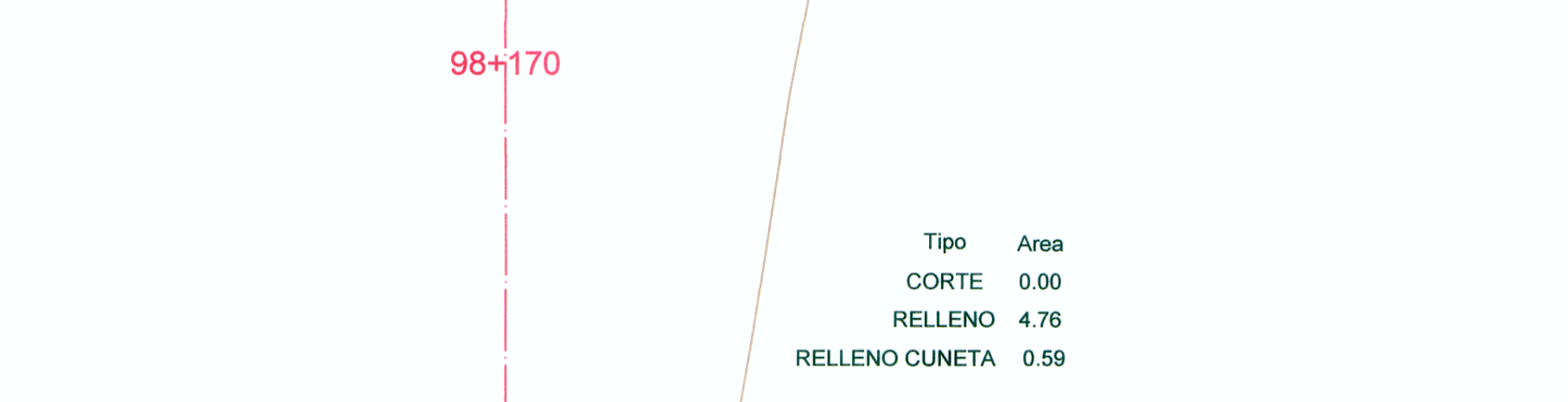
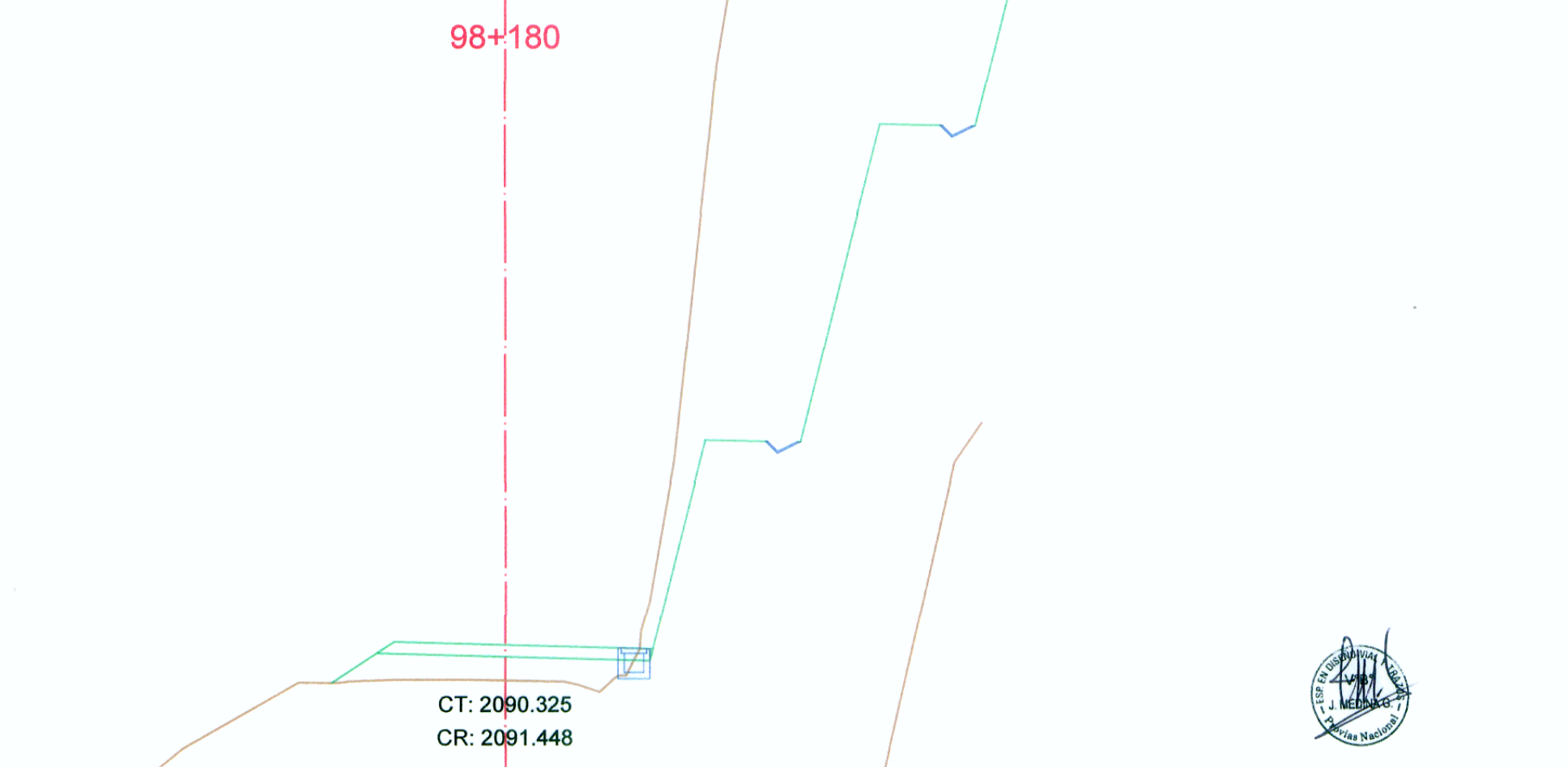
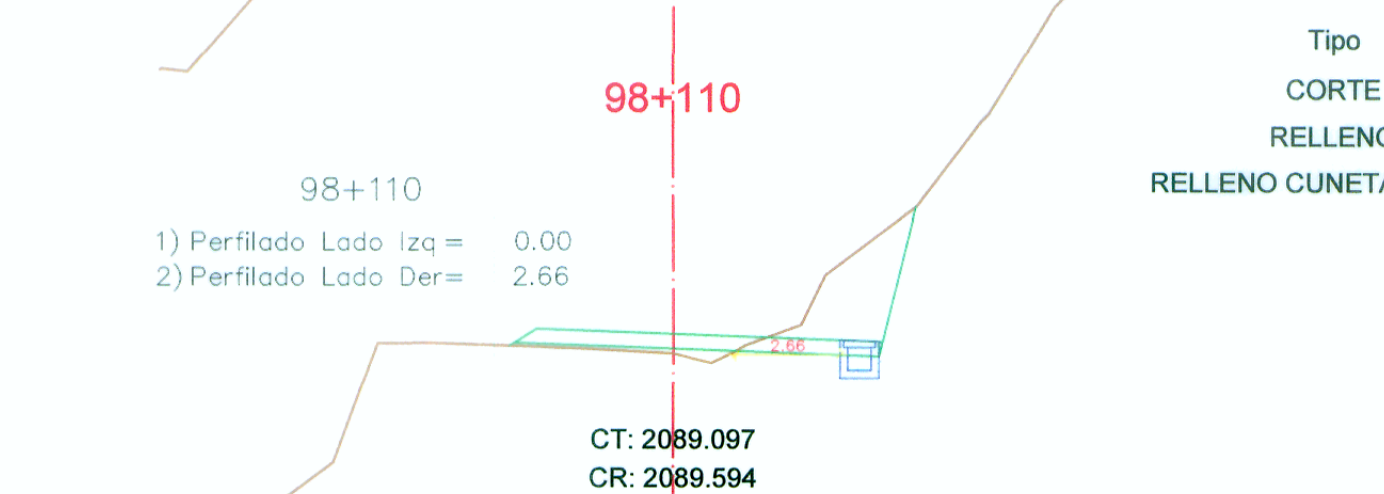
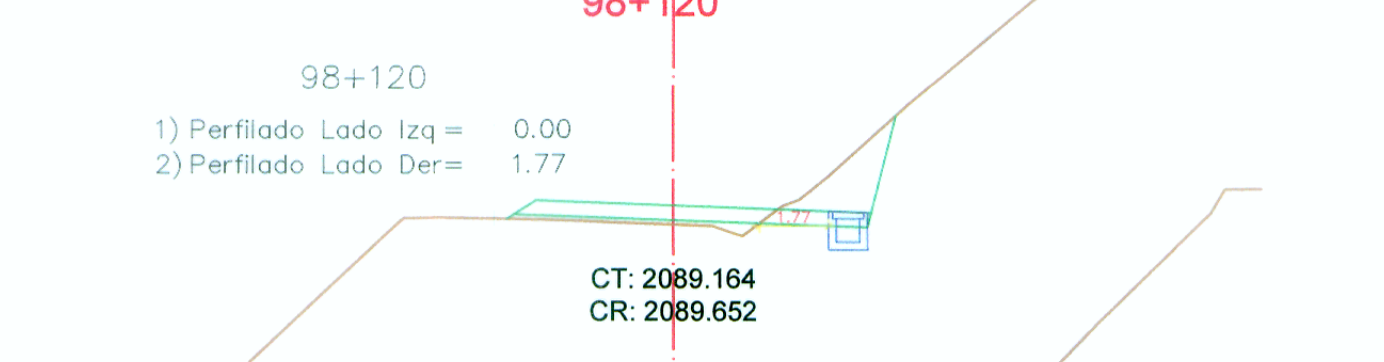
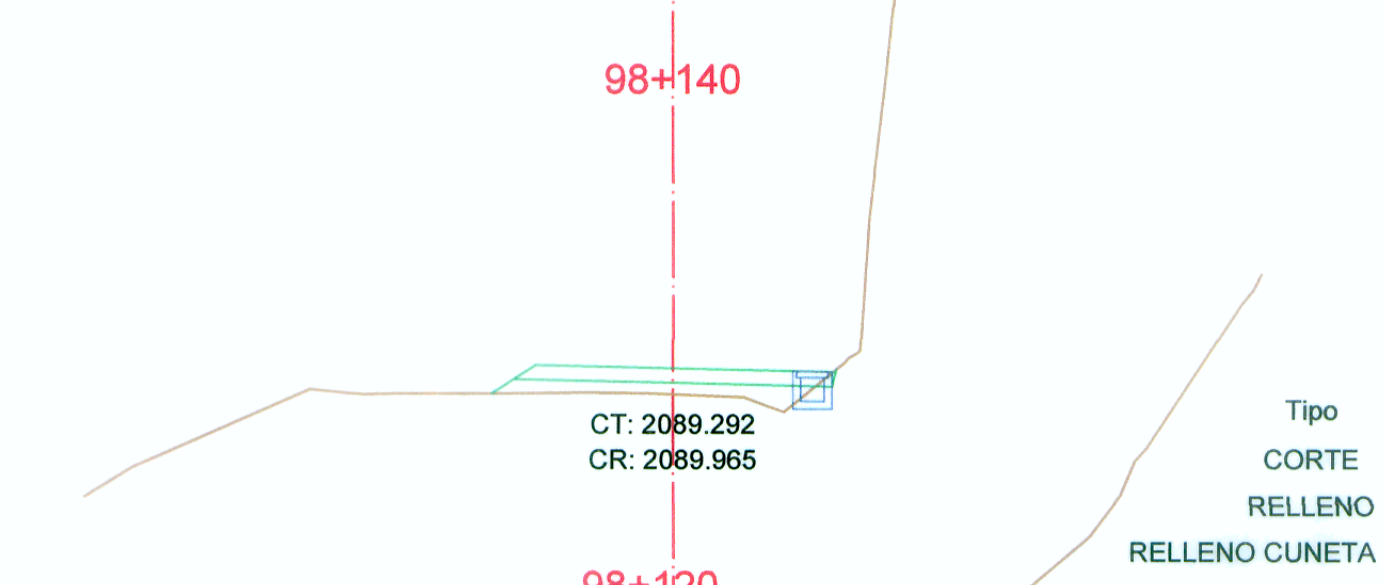
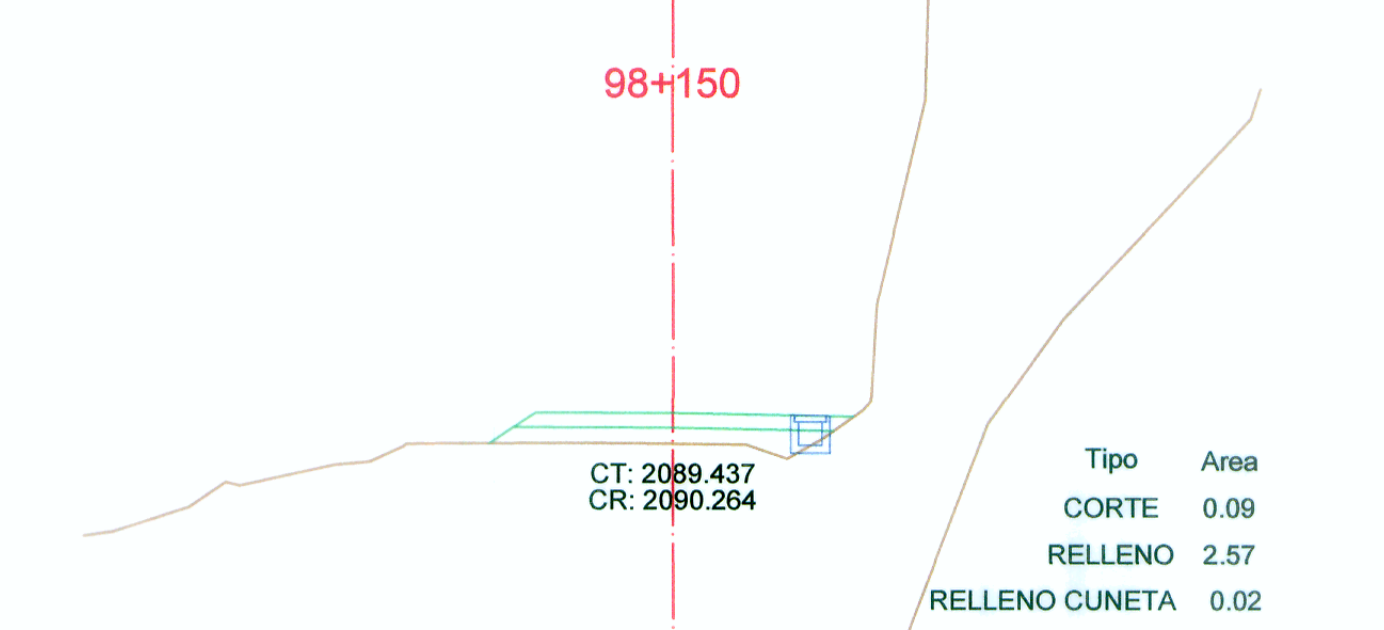
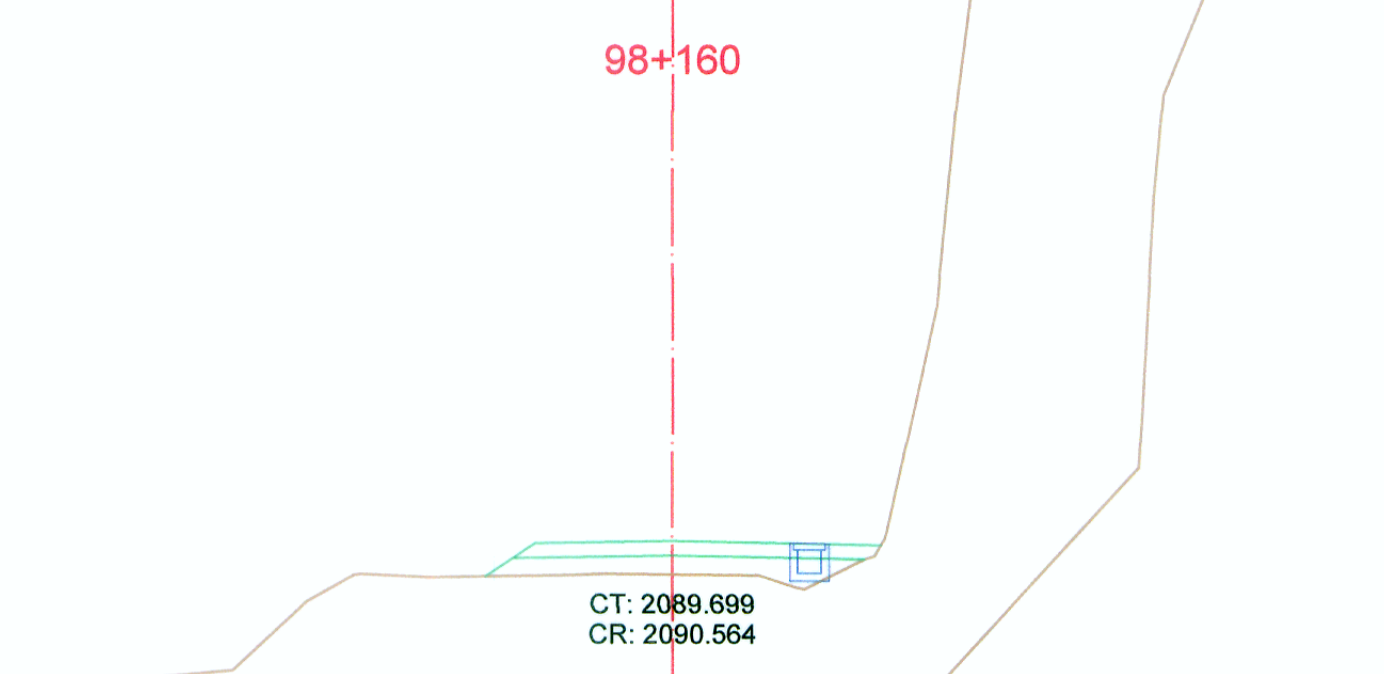

Estudio Definitivo del Proyecto de Rehabilitación y Mejoramiento de la Carretera Huarura - Sayan - Churín con Sección de Pavimento de Tipo 104+200

Ing. María Mayorca
Reg. C.I.P. 9434