

- CE = REFERENCIAL
- CSA = REFERENCIAL
- CAB. ENT. = CABEZAL NORMAL
- CAB. SAL. = ---
- S% = 2.00%
- LONG.(TMC) = 8.15m.

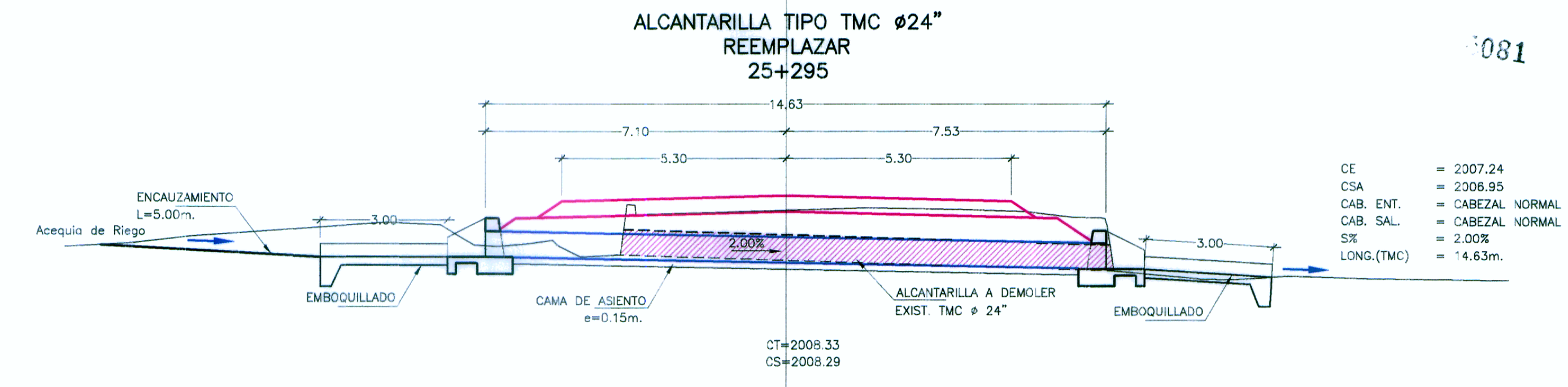

- CE = 2007.24
- CSA = 2006.95
- CAB. ENT. = CABEZAL NORMAL
- CAB. SAL. = CABEZAL NORMAL
- S% = 2.00%
- LONG.(TMC) = 14.63m.

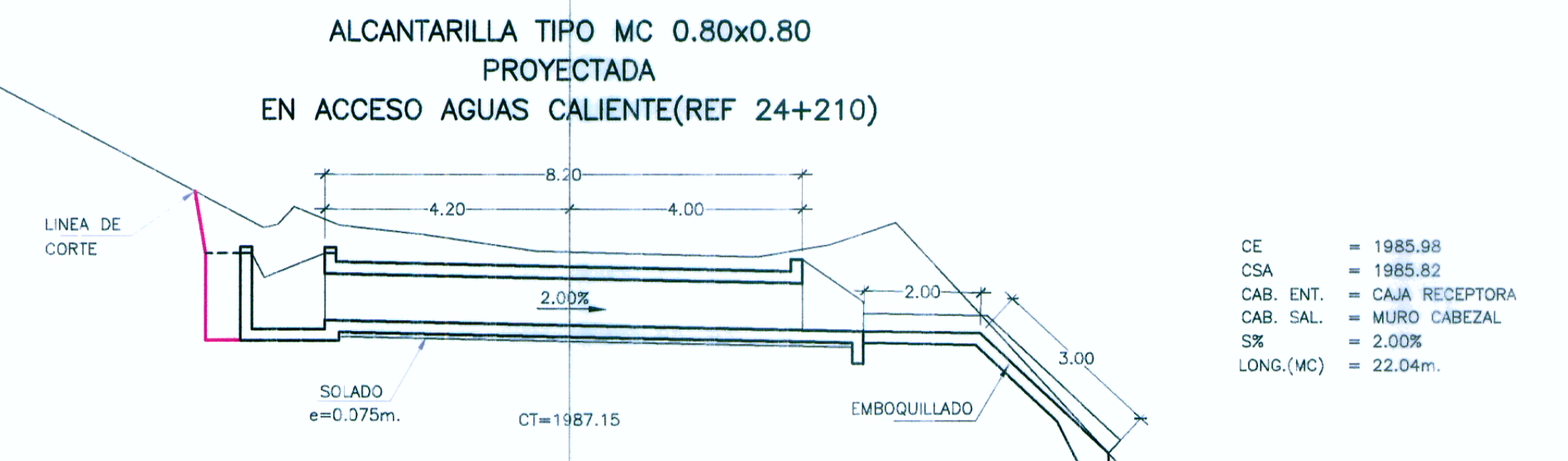

- CE = 1985.98
- CSA = 1985.82
- CAB. ENT. = CAJA RECEPTORA
- CAB. SAL. = MURO CABEZAL
- S% = 2.00%
- LONG.(MC) = 22.04m.

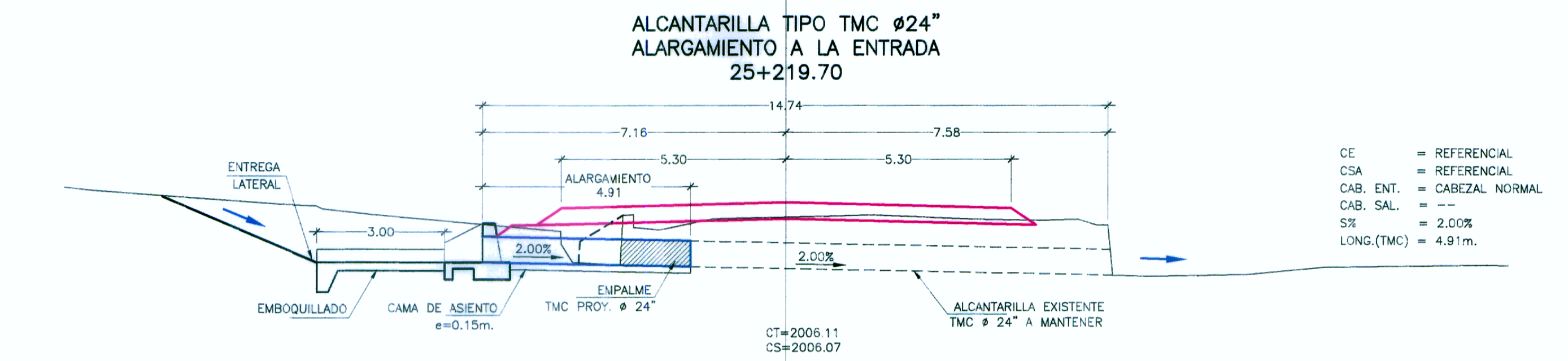

- CE = REFERENCIAL
- CSA = REFERENCIAL
- CAB. ENT. = CABEZAL NORMAL
- CAB. SAL. = ---
- S% = 2.00%
- LONG.(TMC) = 4.91m.

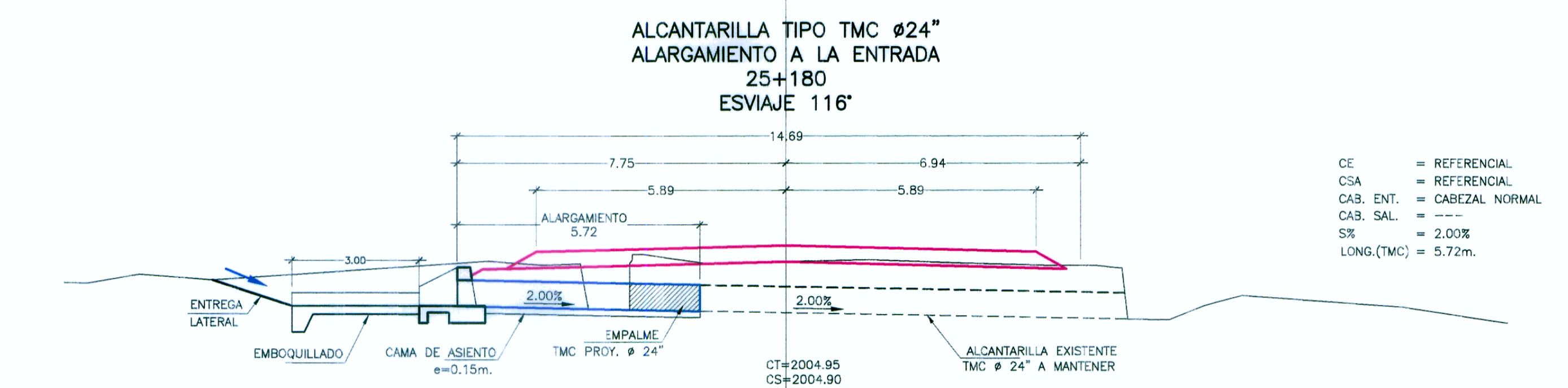

- CE = REFERENCIAL
- CSA = REFERENCIAL
- CAB. ENT. = CABEZAL NORMAL
- CAB. SAL. = ---
- S% = 2.00%
- LONG.(TMC) = 5.72m.

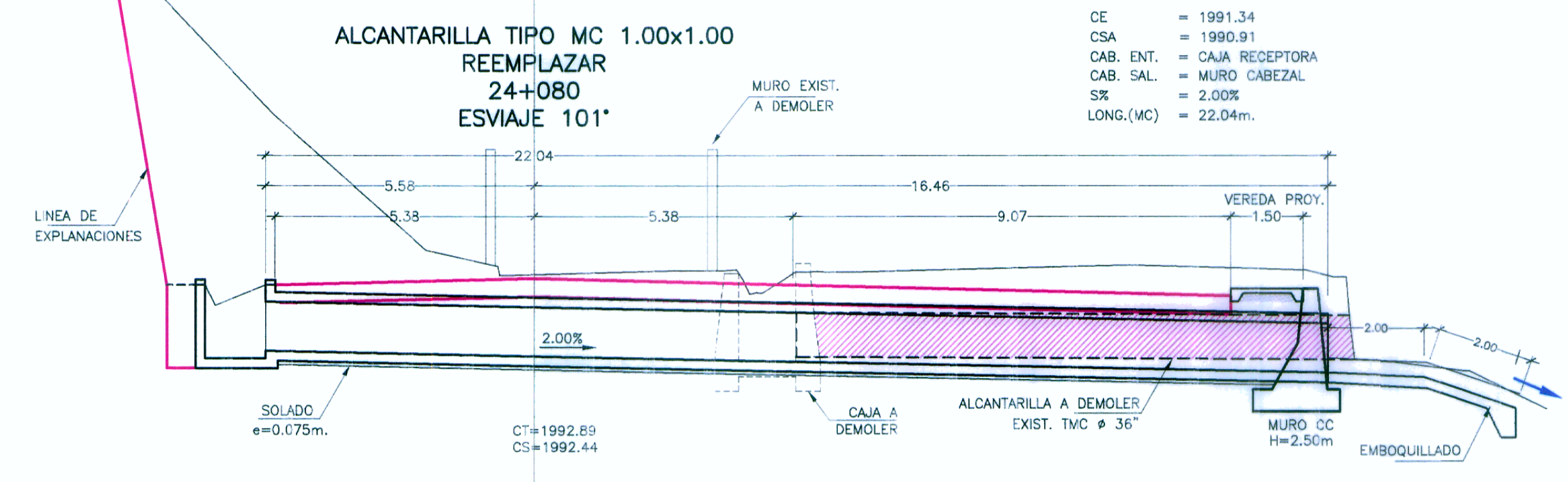

- CE = 1991.34
- CSA = 1990.91
- CAB. ENT. = CAJA RECEPTORA
- CAB. SAL. = MURO CABEZAL
- S% = 2.00%
- LONG.(MC) = 22.04m.

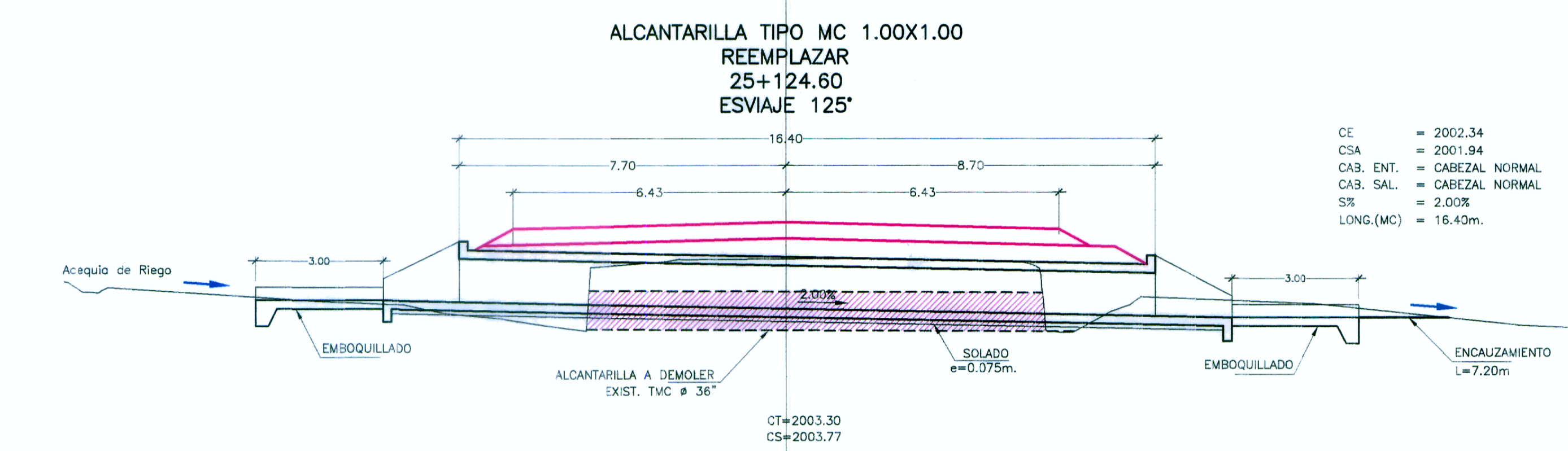

- CE = 2002.34
- CSA = 2001.94
- CAB. ENT. = CABEZAL NORMAL
- CAB. SAL. = CABEZAL NORMAL
- S% = 2.00%
- LONG.(MC) = 16.40m.

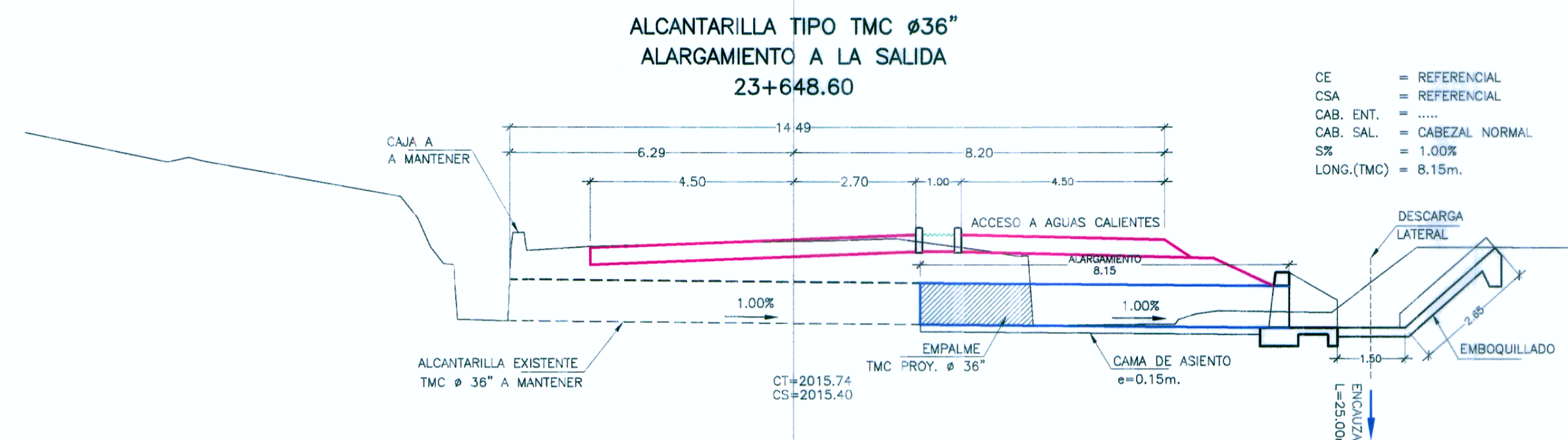

- CE = REFERENCIAL
- CSA = REFERENCIAL
- CAB. ENT. =
- CAB. SAL. = CABEZAL NORMAL
- S% = 1.00%
- LONG.(TMC) = 8.15m.

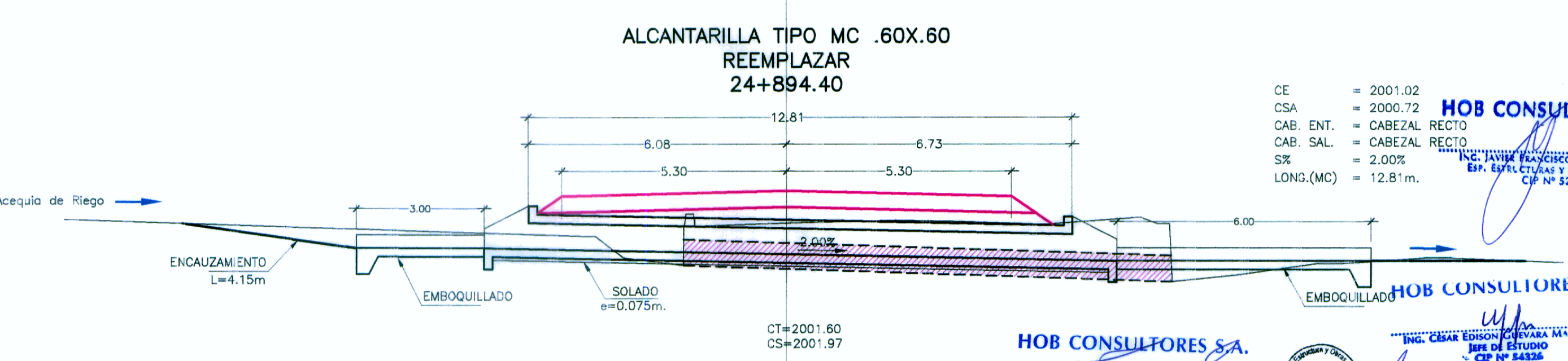

- CE = 2001.02
- CSA = 2000.72
- CAB. ENT. = CABEZAL RECTO
- CAB. SAL. = CABEZAL RECTO
- S% = 2.00%
- LONG.(MC) = 12.81m.

REVISIONES	
N°	FECHA